

TSF65R360S2

650V 13A N-Channel SJ-MOSFET

General Description

Truesemi SJ-FET is new generation of high voltage MOSFET family that is utilizing an advanced charge balance mechanism for outstanding low on-resistance and lower gate charge performance. This advanced technology has been tailored to minimize conduction loss, provide superior switching performance, and withstand extreme dv/dt rate and higher avalanche energy. SJ-FET is suitable for various AC/DC power conversion in switching mode operation for higher efficiency.

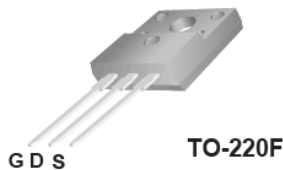

Features

- 700V @T_J = 150 °C
- Typ. R_{DS(on)} = 0.34Ω
- Ultra Low gate charge (typ. Q_g = 43nC)
- 100% avalanche tested



Absolute Maximum Ratings

Symbol	Parameter	Value	Unit
V _{DSS}	Drain-Source Voltage	650	V
I _D	Drain Current -Continuous (TC = 25°C) -Continuous (TC = 100°C)	13* 9.1*	A
I _{DM}	Drain Current – Pulsed (Note 1)	42*	A
V _{GSS}	Gate-Source voltage	±30	V
E _{AS}	Single Pulsed Avalanche Energy (Note 2)	205	mJ
I _{AR}	Avalanche Current (Note 1)	2.4	A
E _{AR}	Repetitive Avalanche Energy (Note 1)	0.43	mJ
dv/dt	Peak Diode Recovery dv/dt (Note 3)	15	V/ns
P _D	Power Dissipation (TC = 25°C)	32	W
T _J , T _{STG}	Operating and Storage Temperature Range	-55 to +150	°C
T _L	Maximum Lead Temperature for Soldering Purpose, 1/8" from Case for 5 Seconds	300	°C

* Drain current limited by maximum junction temperature.

Thermal Characteristics

Symbol	Parameter	Value	Unit
R _{θJC}	Thermal Resistance, Junction-to-Case	3.9	°C/W
R _{θCS}	Thermal Resistance, Case-to-Sink Typ.	--	°C/W
R _{θJA}	Thermal Resistance, Junction-to-Ambient	80	°C/W

Electrical Characteristics TC = 25 °C unless otherwise noted

Symbol	Parameter	Conditions	Min	Typ	Max	Unit
Off Characteristics						
BV _{DSS}	Drain-Source Breakdown Voltage	V _{GS} = 0V, I _D = 250μA, T _J = 25 °C	650	--	--	V
		V _{GS} = 0V, I _D = 250μA, T _J = 150 °C	--	700	--	V
ΔBV _{DSS} / ΔT _J	Breakdown Voltage Temperature Coefficient	I _D = 250μA, Referenced to 25 °C	--	0.6	--	V/°C
I _{DSS}	Zero Gate Voltage Drain Current	V _{DS} = 650V, V _{GS} = 0V - T _J = 150 °C	--	-- 10	1 --	μA μA
I _{GSSF}	Gate-Body Leakage Current, Forward	V _{GS} = 30V, V _{DS} = 0V	--	--	100	nA
I _{GSSR}	Gate-Body Leakage Current, Reverse	V _{GS} = -30V, V _{DS} = 0V	--	--	-100	nA
On Characteristics						
V _{GS(th)}	Gate Threshold Voltage	V _{DS} = V _{GS} , I _D = 250μA	2.5	--	4.5	V
R _{DS(on)}	Static Drain-Source On-Resistance	V _{GS} = 10V, I _D = 6.5A	--	0.34	0.38	Ω
g _{FS}	Forward Trans conductance	V _{DS} = 10V, I _D = 7.0A (Note 4)	--	12	--	S
R _g	Gate resistance	f=1MHz, open drain	--	3.5	--	Ω
Dynamic Characteristics						
C _{iss}	Input Capacitance	V _{DS} = 25V, V _{GS} = 0V, f = 1.0MHz	--	1000	--	pF
C _{oss}	Output Capacitance		--	340	--	pF
C _{rss}	Reverse Transfer Capacitance		--	10	--	pF
Switching Characteristics						
t _{d(on)}	Turn-On Delay Time	V _{DD} = 400V, I _D = 7.5A R _G = 20Ω (Note 4, 5)	--	13	--	ns
t _r	Turn-On Rise Time		--	11	--	ns
t _{d(off)}	Turn-Off Delay Time		--	100	--	ns
t _f	Turn-Off Fall Time		--	12	--	ns
Q _g	Total Gate Charge	V _{DS} = 480V, I _D = 7.5A V _{GS} = 10V (Note 4, 5)	--	43	--	nC
Q _{gs}	Gate-Source Charge		--	5	--	nC
Q _{gd}	Gate-Drain Charge		--	22	--	nC
Drain-Source Diode Characteristics and Maximum Ratings						
I _S	Maximum Continuous Drain-Source Diode Forward Current		--	--	15	A
I _{SM}	Maximum Pulsed Drain-Source Diode Forward Current		--	--	40	A
V _{SD}	Drain-Source Diode Forward Voltage	V _{GS} = 0V, I _F = 7.5A	--	0.9	1.5	V
t _{rr}	Reverse Recovery Time	V _{GS} = 0V, I _F = 7.5A di _F /dt = 100A/μs (Note 4)	--	345	--	ns
Q _{rr}	Reverse Recovery Charge		--	4.5	--	μC

NOTES:

1. Repetitive Rating: Pulse width limited by maximum junction temperature
2. I_{AS}=2.4A, V_{DD}=50V, Starting T_J=25 °C
3. I_{SD}≤15A, di/dt ≤ 200A/μs, V_{DD} ≤ BV_{DSS}, Starting T_J = 25 °C
4. Pulse Test: Pulse width ≤ 300μs, Duty Cycle ≤ 2%
5. Essentially Independent of Operating Temperature Typical Characteristics

Typical Performance Characteristics

Power dissipation

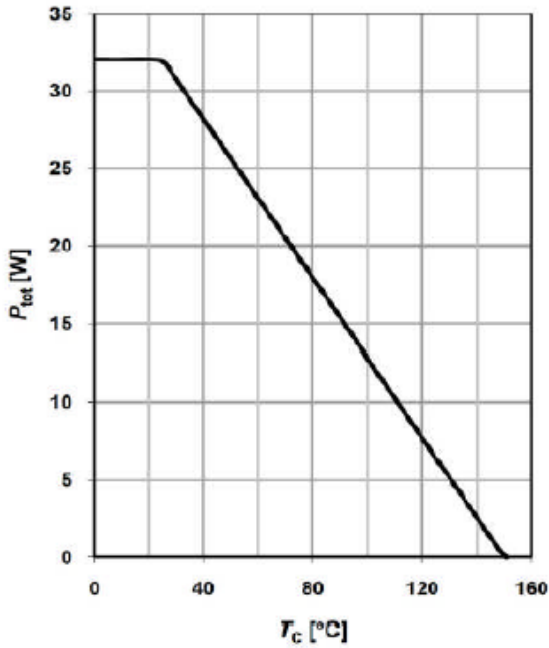

Max. transient thermal impedance

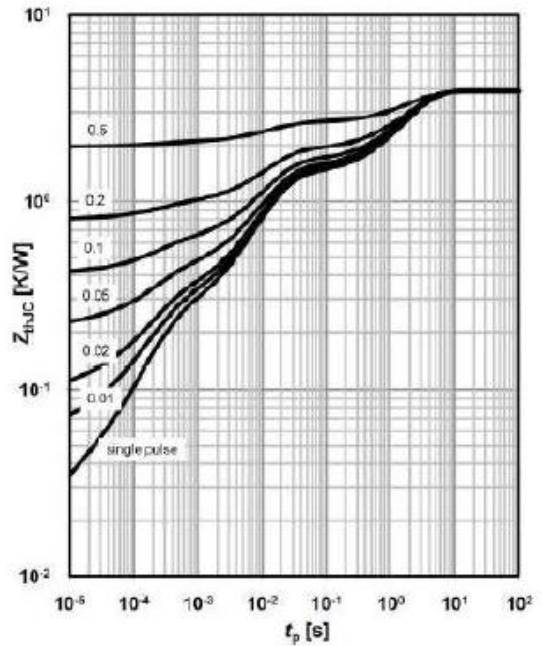

Safe operating area $T_c=25^{\circ}C$

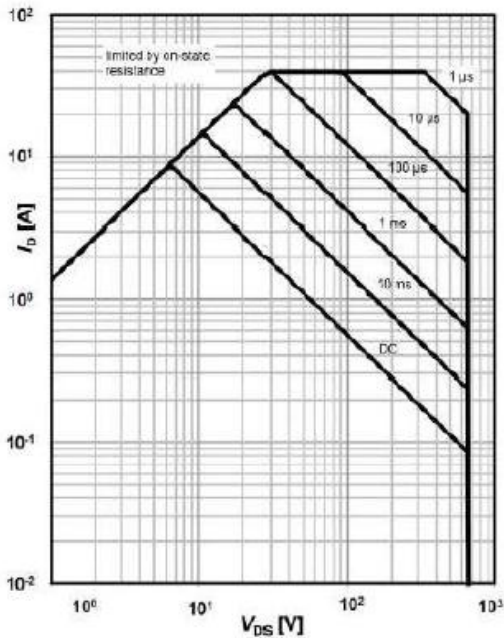

$I_D=f(V_{DS}); T_c=25^{\circ}C; V_{GS} > 7V;$
 $D=0;$ parameter t_p

Safe operating area $T_c=80^{\circ}C$

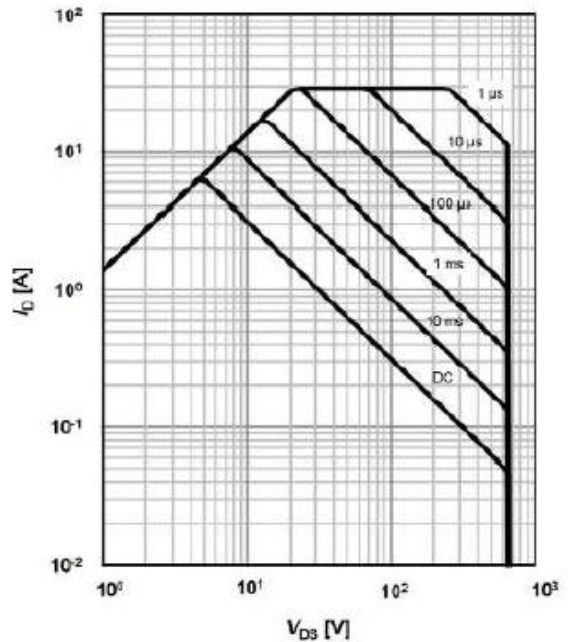

$I_D=f(V_{DS}); T_c=80^{\circ}C; V_{GS} > 7V;$
 $D=0;$ parameter t_p

Typical Performance Characteristics

Typ. output characteristics $T_j=25\text{ }^\circ\text{C}$

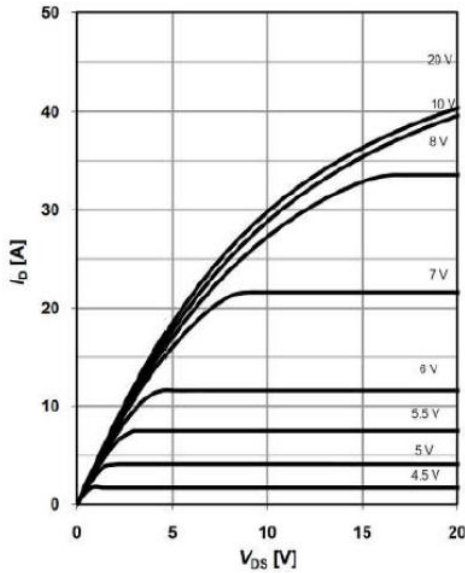

$I_D=f(V_{DS}); T_j=25\text{ }^\circ\text{C}$; parameter: V_{GS}

Typ. output characteristics $T_j=125\text{ }^\circ\text{C}$

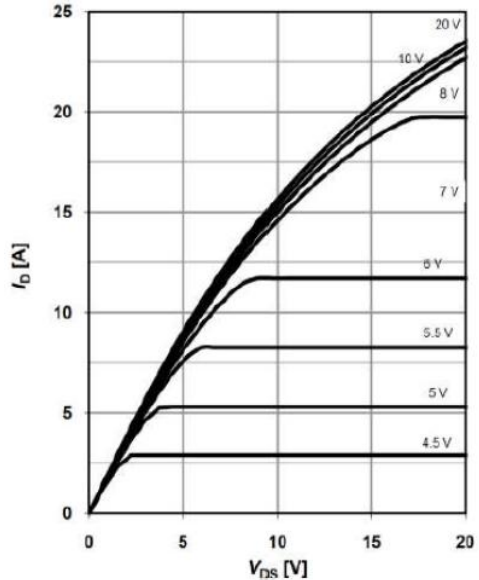

$I_D=f(V_{DS}); T_j=125\text{ }^\circ\text{C}$; parameter: V_{GS}

Typ. drain-source on-state resistance

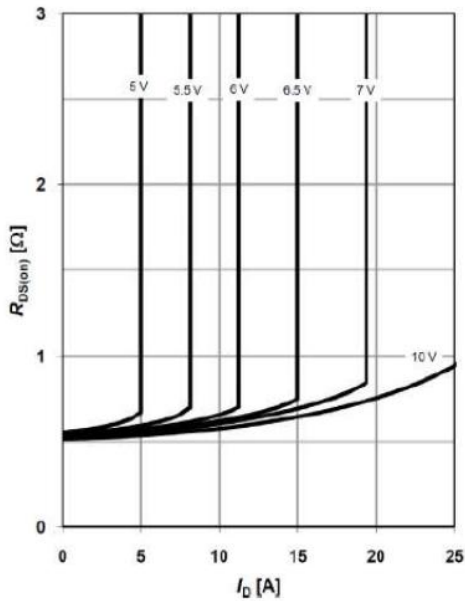

$R_{DS(on)}=f(I_D); T_j=125\text{ }^\circ\text{C}$;
parameter: V_{GS}

Typ. drain-source on-state resistance

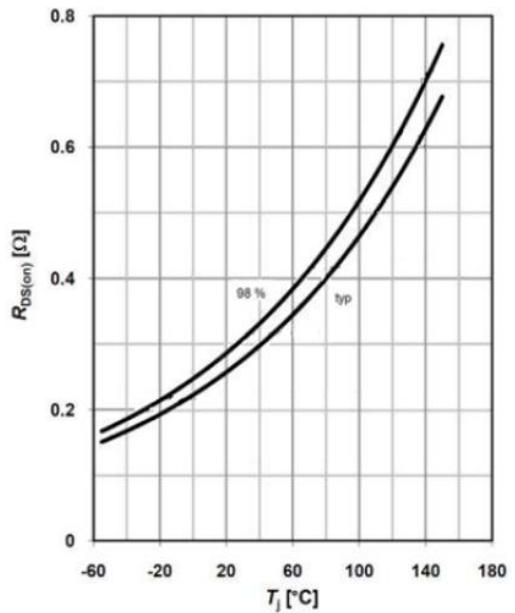

$R_{DS(on)}=f(T_j); I_D=4.4\text{ A}; V_{GS}=10\text{ V}$

Typical Performance Characteristics

Typ. transfer characteristics

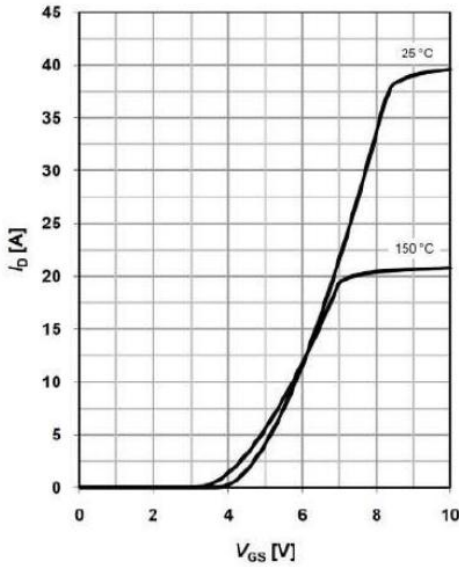

$I_D = f(V_{GS}); V_{DS} = 20V$

Typ. gate charge

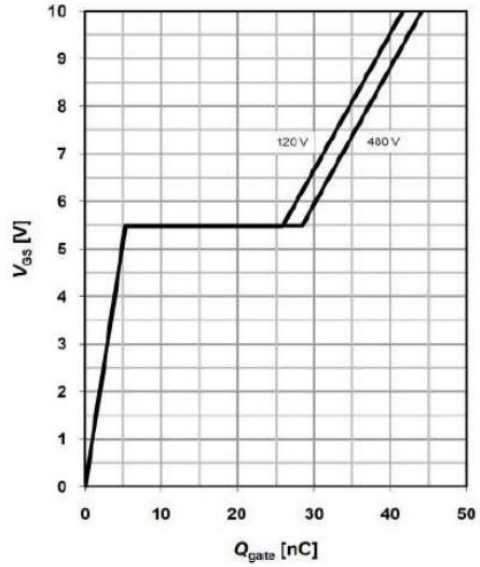

$V_{GS} = f(Q_g), I_D = 4.4 A \text{ pulsed}$

Avalanche energy

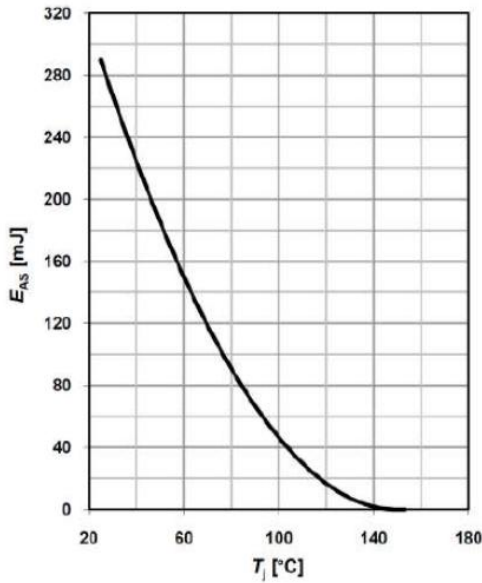

$E_{AS} = f(T_j); I_D = 2.4A; V_{DD} = 50 V$

Drain-source breakdown voltage

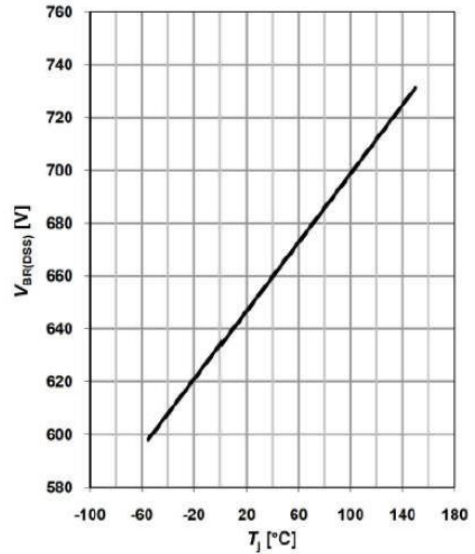

$V_{BR(DSS)} = f(T_j); I_D = 0.25mA$

Typical Performance Characteristics

Typ. capacitances

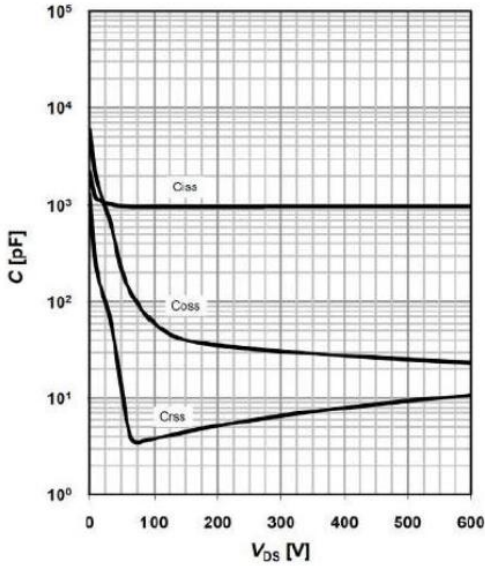

$C=f(V_{DS}); V_{GS}=0 V; f=1 MHz$

Typ. *Coss* stored energy

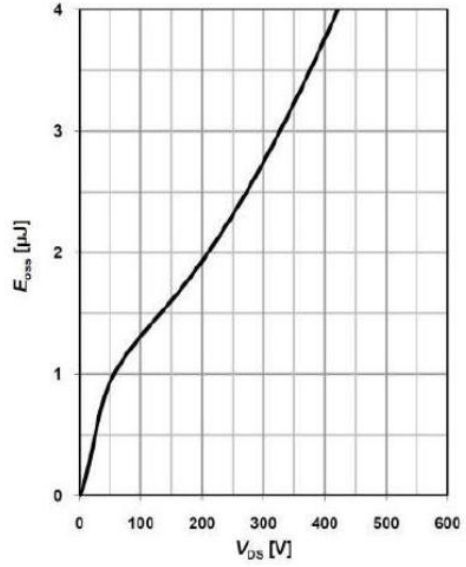

$E_{OSS}=f(V_{DS})$

Forward characteristics of reverse diode

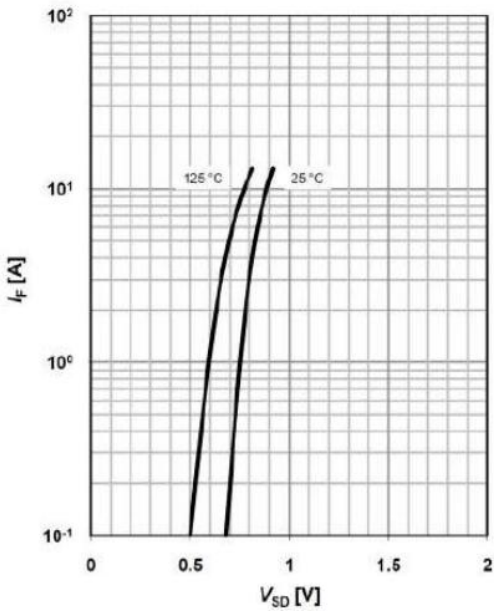

$I_F=f(V_{SD}); \text{parameter: } T_j$

Test circuits

Switching times test circuit and waveform for inductive load

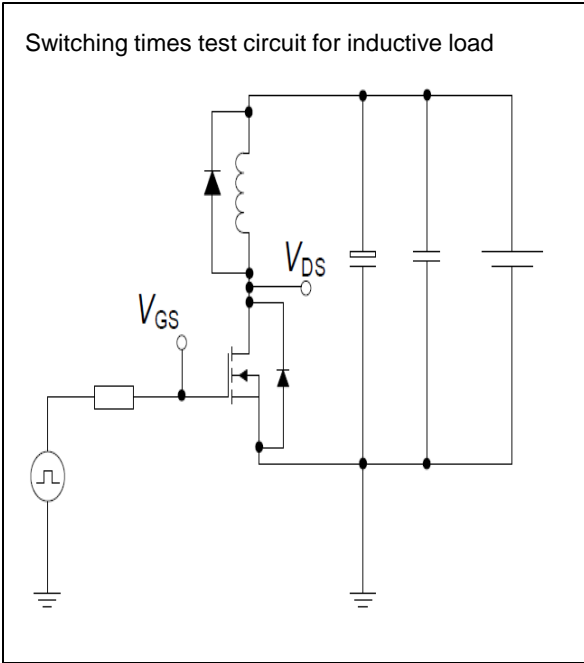

Unclamped inductive load test circuit and waveform

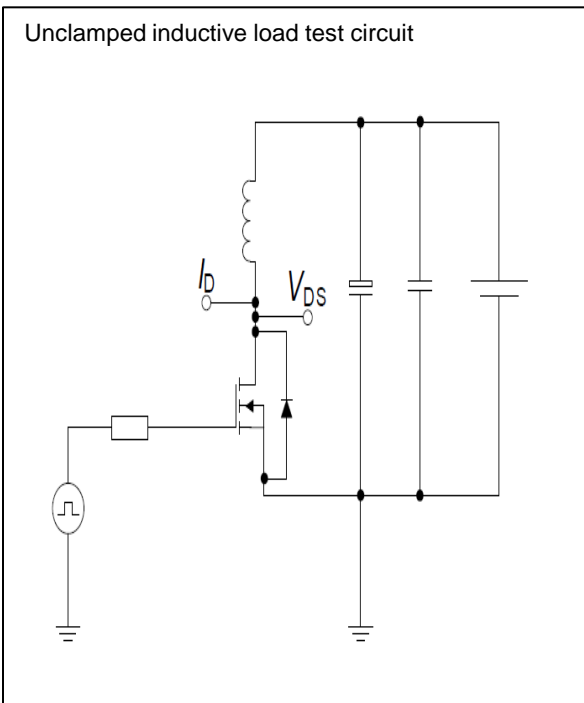

Test circuits

Test circuit and waveform for diode characteristics

